

SOLUTION
GRANDS
CARREAUX

Léger

Extra-plat
Redécoupable

Natte étanche
pré-montée

Compatible
tous carreaux

Siphon
ultra-plat

SUR
MESURE

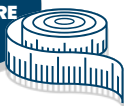

Solutions receveurs à carreler

ÉCOULEMENT CANIVEAU

monoboard[®]

Solution design spéciale grands carreaux.

Receveur à carreler caniveau avec siphon ultra-plat et natte étanche pré-montée.

Existe aussi en siphon à 360° sur demande
Possibilité d'avoir un siphon vertical sur demande (avec délais)

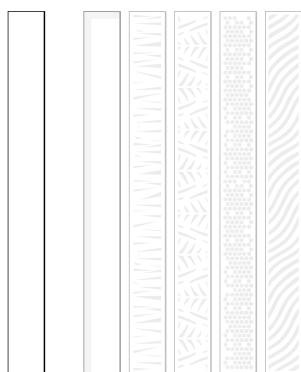
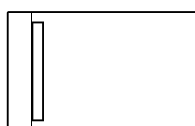

STANDARD

EN OPTION

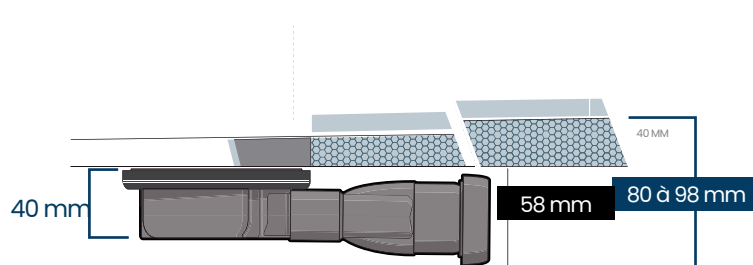

SIPHONS ULTRA PLAT
HORIZONTAL

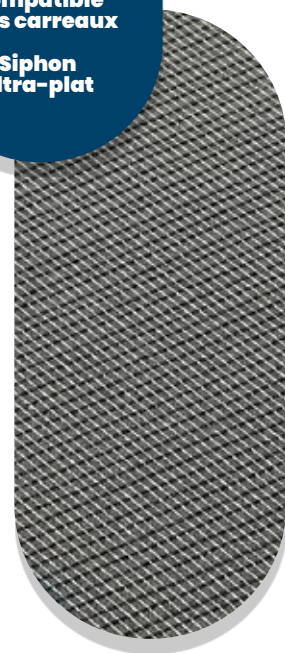

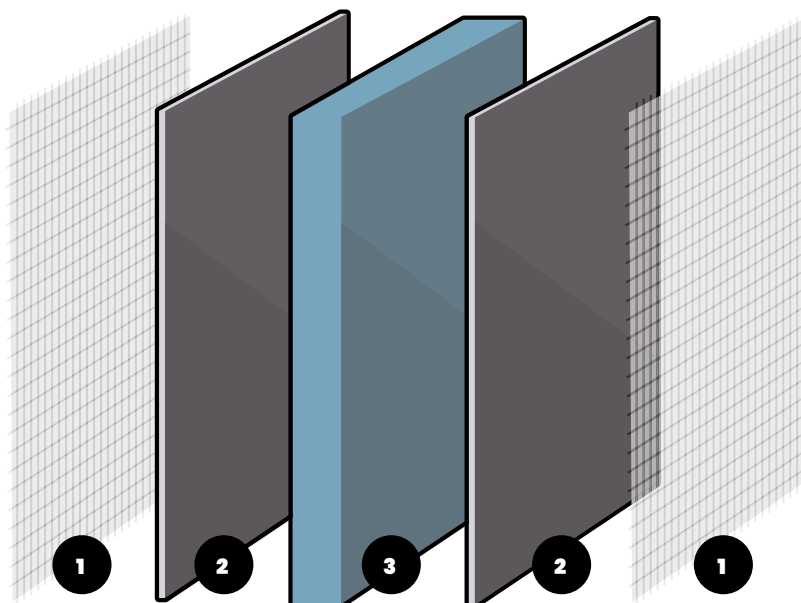
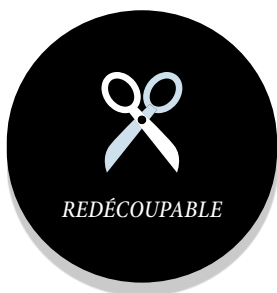

Composition d'un receveur **monoboard**®

1 - Fibre de verre extérieure | 2 - Mortier ciment polymérisé | 3 - Mousse polystyrène extrudée

Poids allégé : 20 kilos du m²

Pentes importantes supérieures à 2% pour une évacuation rapide de l'eau

Découpe : disque Diamant

Encollage: Mortier colle flex type C2S ou colle PU Kemflex

Natte étanche embarqué scellée avec la bride du siphon pour une garantie d'étanchéité périphérique.

Grille acier inox brossé : Acier inox 304 de 2 mm d'épaisseur.

Couleur des grilles : Revêtement anodisé epoxy

Résistant à tous les produits détergents

CE

Déclaration de performance disponible

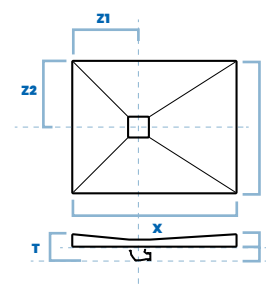

monoboard® Format rectangulaire – version siphon ultra plat

REF	FORMAT	X LONGUEUR (mm)	Y LARGEUR (mm)	Z2/Z1 POSITION BONDE (mm)	E ÉPAISSEUR BAC (mm)	F ÉPAISSEUR SOUS RECEVEUR (mm)	T ÉPAISSEUR TOTAL AVEC RECEVEUR (mm)
RC12090 MONO	DÉCENTRÉ*	1200	900	450 / 135	40	40 à 58	80 à 98
RC14090 MONO	DÉCENTRÉ*	1400	900	450 / 135	40	40 à 58	80 à 98
RC150100 MONO	DÉCENTRÉ*	1500	1000	500 / 135	40	40 à 58	80 à 98
RC185100 MONO	DÉCENTRÉ*	1850	1000	500 / 135	40	40 à 58	80 à 98

*FORMAT BAIGNOIRE



! Nous vous recommandons de lire intégralement la notice avant de commencer votre installation. Utilisation de pieds ou plots de receveur interdite.
We recommend that you read all the instructions carefully before starting to install your shower. Never use shower tray feet or mounting blocks.

Wij raden u aan de montagehandleiding aandachtig te lezen vóór u met de plaatsing begint. Het gebruik van voetjes of blokjes bij de douchebak is verboden.

Le aconsejamos que lea las instrucciones completamente antes de empezar la instalación. Prohibido el uso de pies o tacos de plato de ducha.

Wir empfehlen Ihnen, die Montageanweisung vor Beginn der Montage vollständig zu lesen. Die Verwendung von Duschwannenfüßen ist unzulässig.

Recomendamos que leia totalmente o folheto informativo antes de iniciar a instalação. Não é permitida a utilização de apoios ou cavilhas para base de duche.

Leggere le istruzioni nella loro integralità prima di procedere all'installazione. È vietato utilizzare piedi o blocchetti per piatto doccia.

Рекомендуем внимательно прочесть инструкцию по сборке перед началом работ. Запрещено устанавливать душевой поддон на ножки или подставки.



not included

- 1** Mortier/Mortar/Mortel/Mortero/Mörtel/Cimento/Malta/Строительный раствор
- 2** Colle PVC/PVC adhesive/PVC-lijm/Cola de PVC/PVC-Kleber/Cola de PVC/Colla PVC/клей ПВХ
- 3** Colle carrelage/Tiling glue/Tegellijm/Cola para azulejos/Fliesenkleber/Cola de ladrillo/Colla per piastrelle/ Плиточный клей
- 4** Bande de résilience/ Adhesive sealing band/ Slagsterkstreek/ Cinta resiliente/ selbstklebendes Abdichtband für Duschbecken/ Fita de vedação/ Nastro di resilienza/ Самоклеящаяся гидроизоляционная лента
- 5** Enduit d'imperméabilisation/Sealant/Waterdichtende afdekking/ Recubrimiento de impermeabilización/Dichtungsmasse/ Camada de impermeabilização/Rivestimento di impermeabilizzazione/ Изоляционное покрытие

not included

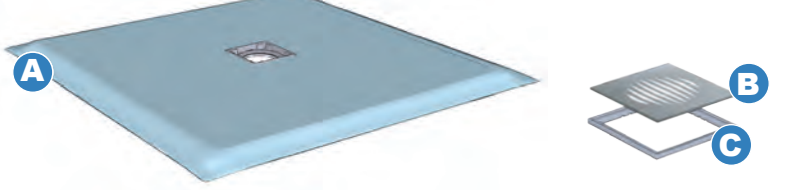

JAMES



not included

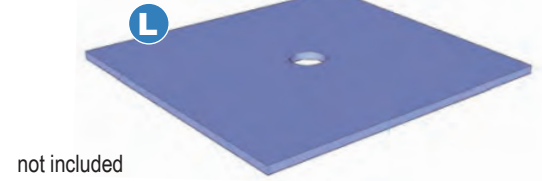

not included

SLIM

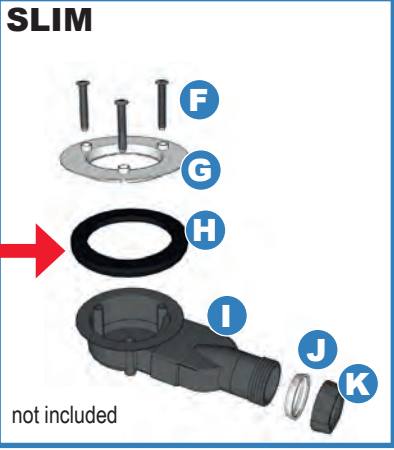

not included

Or

